



ARB ARB Series™

Rectangular, Plastic, Heavy-Duty Connectors for Bulkhead Applications

Available in 48 and 102 position

Amphenol Sine Systems' **ARB Series™ Connectors** are IP68 and IP69K rated (in mated condition), rectangular, thermoplastic, heavy-duty, environmentally-sealed, connector series where high pin-counts are required in situations with controlled and/or uncontrolled environmental conditions such as bulkhead applications. The interface flange with receptacle retaining clip, jackscrew (plug), and threaded insert (receptacle) are all utilized to ensure a secure mated assembly. Our **ARB Series™ Connectors** have been developed to be comparable with other existing standard products industry-wide.

Our **ARB Series™** connectors utilize **A Series™ Contacts**. See individual datasheets for required tooling and contact details.

Key Features

- IP68/IP69K (in mated condition)
- Available in A, B, C and D Keying Options
- Utilize A Series™ Contacts
- Interface Flange w Receptacle Retaining Clip, Jackscrew (Plug), and Threaded Insert (Receptacle) for secure mating of complete assembly
- Comparable with existing standard products industry-wide
- Optional **A Series™ Protective Backshell Boots** available



Applications: Transportation, Off-Highway, Heavy Equipment, Agricultural, Automotive, Alternate Energy, Marine and other demanding interconnect architectures.

ARB Series™ - Specifications

Operating Temperature	-55°C to +125°C
Current Rating Range (Amp)	#20: 7.5A; #16: 13A; #12: 25A; #8: 60A; #4: 100A
Max. Voltage Rating (AC/DC)	250V AC/DC
Mating Cycle Durability	100
IP Rating	IP68/IP69K (in mated condition)
Wire Range	6-22AWG (16.0-0.35mm ²)
Contact Types	Machined, Stamped & Formed (See individual datasheets)
Contact Resistance	#20: < 11mΩ; #16: < 6.0mΩ; #12: < 2.5mΩ; #8: < 1.0mΩ; #4: < 0.6mΩ
Contact Material	Copper Alloy (Gold & Nickel Plating are available)
Sealing Material	Silicone Rubber
Housing/Wedglock Material	Thermoplastic
Coupling Systems	Receptacle Retaining Clip, Jackscrew w Threaded Insert
Dielectric Withstanding Voltage	Dielectric withstanding voltage less than 2 milliamps current leakage @ 1500 volts AC
Insulation Resistance	1000 megohms at 25°C

Shock & Vibration	No obvious damage in appearance, the structure is normal, and there is no disconnection greater than 1μs during the test.
Contact Retention Force	The contact retention force exceeds the following: #20: 20 lbf; #16: 25 lbf; #12: 30 lbf; #8: 35 lbf; #4: 35 lbf
High Temperature Life Test	No evidence of cracking, distortion, or other damage detrimental to the normal operation of the connectors. The insulation resistance shall be no less than 500 megohms.
Thermal Shock	Subjected to 20 cycles at -55°C to +125°C with no evidence of cracking, chipping, permanent dimensional changes or other damage detrimental to the normal operation of the connectors.
Salt Spray	No evidence of corrosion after 96 hrs
RoHS Compliant	All materials meet the requirements of the European Directive. (See website for documentation)

IP Ratings

IP68 rated (Dust tight; 1M of Water for 24 Hours, in mated condition)
IP69K rated (Dust tight; High-Pressure Waterproof, 4 Points (0°, 30°, 60°, 90°), in mated condition)

A Series™ Family



Standard products. Custom solutions
Customer Service +1 800 394 7732



ARB Series™ - Part Numbering Sequence

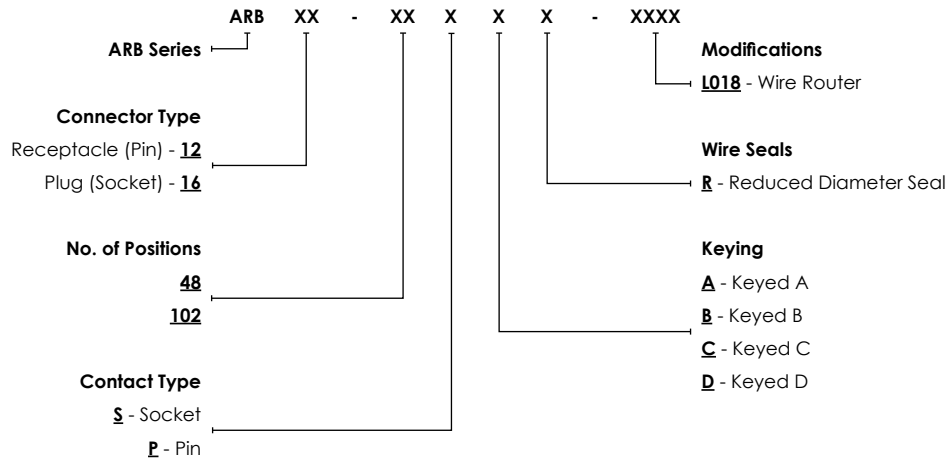

ARB Series™ - 48 Position Insert Arrangement

Note: See datasheets for contact options

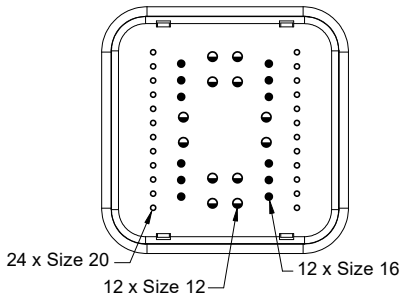

ARB Series™ - 102 Position Insert Arrangement

Note: See datasheets for contact options

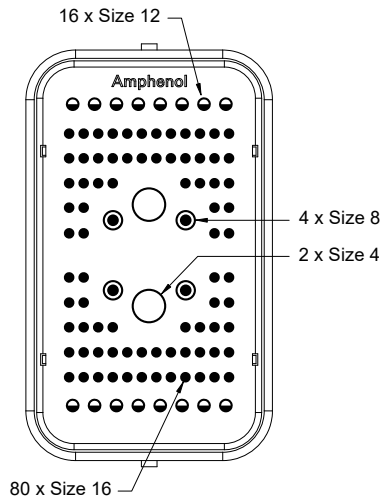

Contact Legend (Size/Amperage)				
Size 4 100A	Size 8 60A	Size 12 25A	Size 16 13A	Size 20 7.5A

ARB Series™ - Components/Assembly Overview

*Refer to pages 6-10 for individual component part numbers

- (A) Receptacle w Threaded Insert for Jackscrew*
- (B) Wedgelock(s)*
- (C) Interface Flange w Receptacle Retaining Clips*
- (D) Plug w Jackscrew*
- (E) Receptacle + Wedgelock(s) Assembly
- (F) Plug + Wedgelock(s) Assembly
- (G) Receptacle + Interface Flange + Plug - Complete Mated Assembly

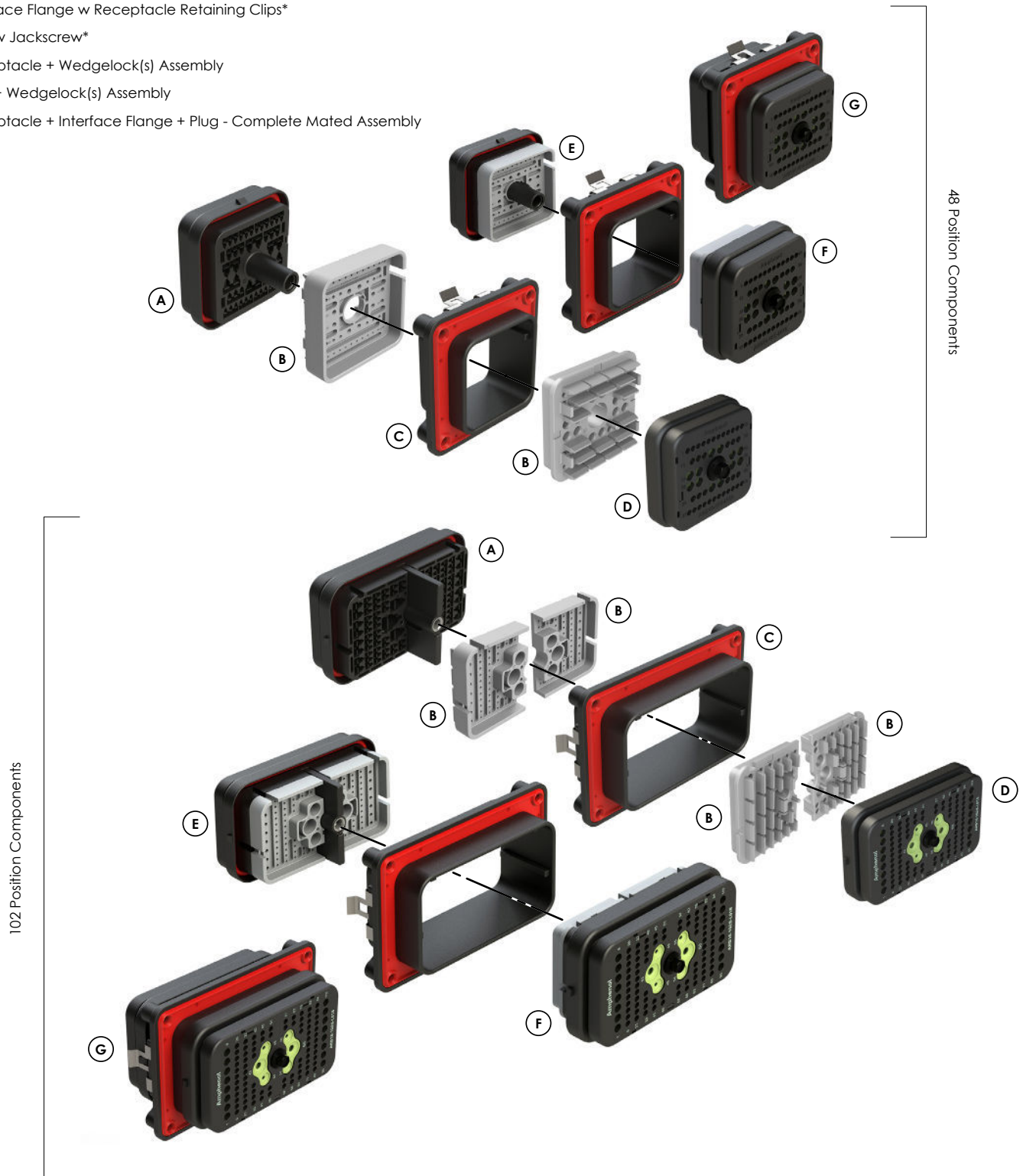

ARB Series™ - 48 Position - Plug and Receptacle Keying Options (A, B, C and D)

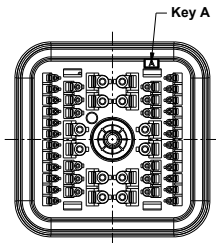

48 Position - Plug - Keyed A
ARB16-48SAR-L018

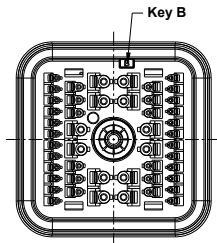

48 Position - Plug - Keyed B
ARB16-48SBR-L018

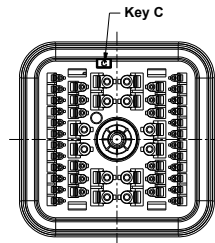

48 Position - Plug - Keyed C
ARB16-48SCR-L018

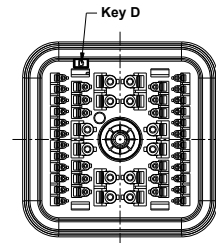

48 Position - Plug - Keyed D
ARB16-48SDR-L018

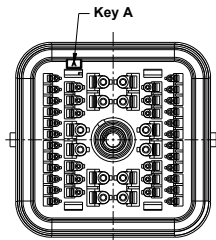

48 Position - Receptacle - Keyed A
ARB12-48PAR-L018

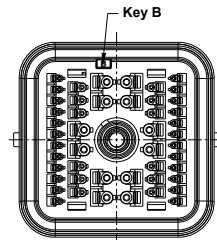

48 Position - Receptacle - Keyed B
ARB12-48PBR-L018

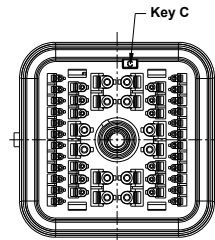

48 Position - Receptacle - Keyed C
ARB12-48PCR-L018

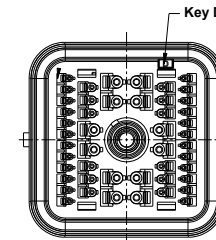

48 Position - Receptacle - Keyed D
ARB12-48PDR-L018

ARB Series™ - 102 Position - Plug and Receptacle Keying Options (A, B, C and D)

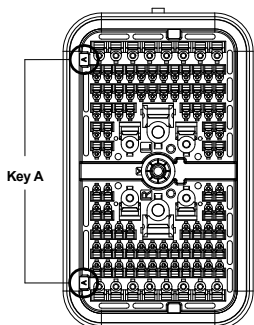

102 Position - Plug - Keyed A
ARB16-102SAR-L018

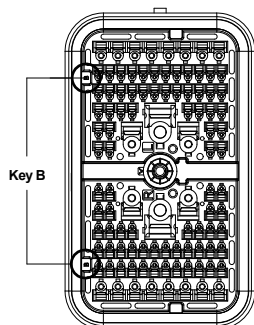

102 Position - Plug - Keyed B
ARB16-102SBR-L018

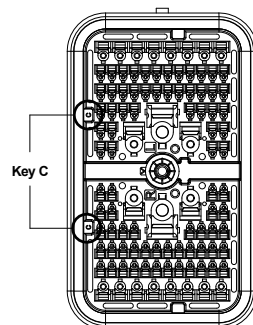

102 Position - Plug - Keyed C
ARB16-102SCR-L018

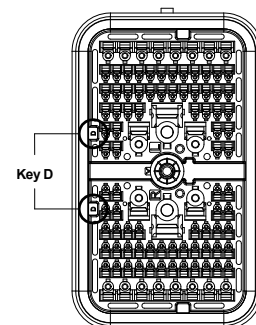

102 Position - Plug - Keyed D
ARB16-102SDR-L018

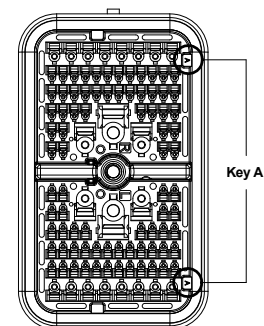

102 Position - Receptacle - Keyed A
ARB12-102PAR-L018

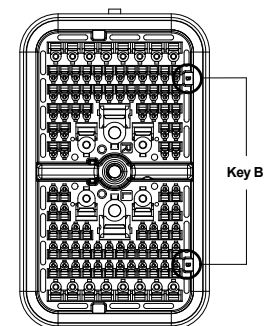

102 Position - Receptacle - Keyed B
ARB12-102PBR-L018

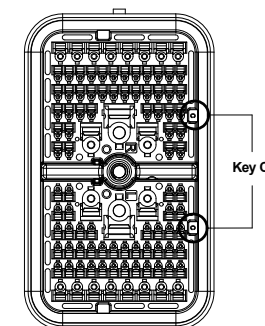

102 Position - Receptacle - Keyed C
ARB12-102PCR-L018

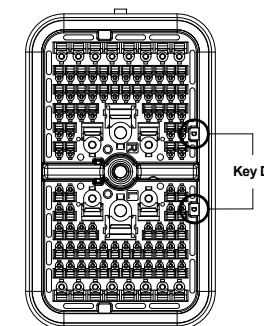

102 Position - Receptacle - Keyed D
ARB12-102PDR-L018

ARB Series™ - 48 Position - Interface Flange Keying Options (A, B, C and D)

Note: A complete ARB Series™ mated assembly requires the use of an Interface Flange.

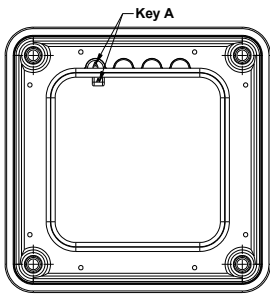

48 Position - Interface Flange - Keyed A
ARBF-2A

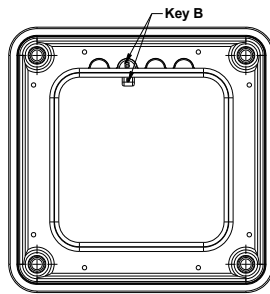

48 Position - Interface Flange - Keyed B
ARBF-2B

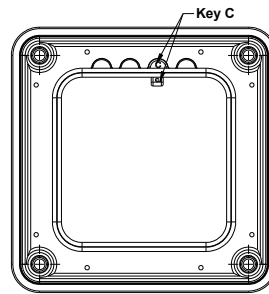

48 Position - Interface Flange - Keyed C
ARBF-2C

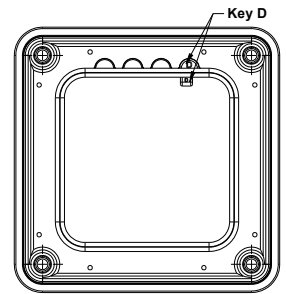

48 Position - Interface Flange - Keyed D
ARBF-2D

ARB Series™ - 102 Position - Interface Flange Keying Options (A, B, C and D)

Note: A complete ARB Series™ mated assembly requires the use of an Interface Flange.

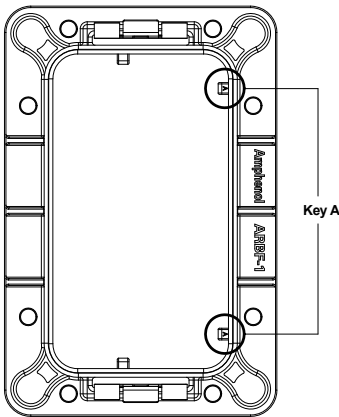

102 Position - Interface Flange - Keyed A
ARBF-1A

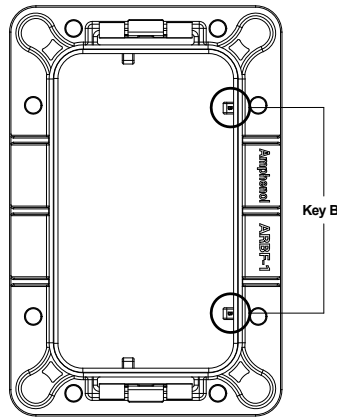

102 Position - Interface Flange - Keyed B
ARBF-1B

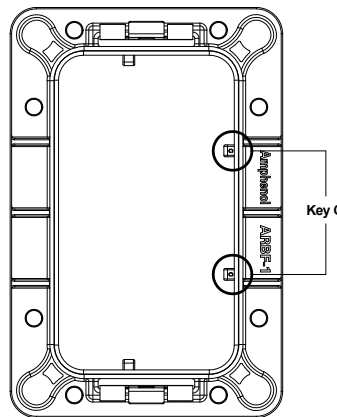

102 Position - Interface Flange - Keyed C
ARBF-1C

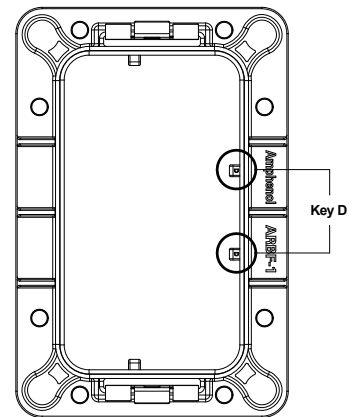

102 Position - Interface Flange - Keyed D
ARBF-1D

ARB Series™ - 48 Position - Interface Flange Panel Cutouts (in mm)

Note: See individual datasheets for specific dimensions relating to keying options

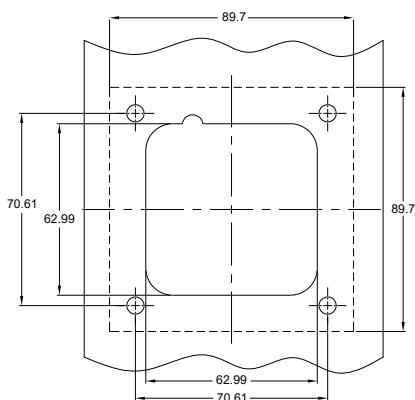





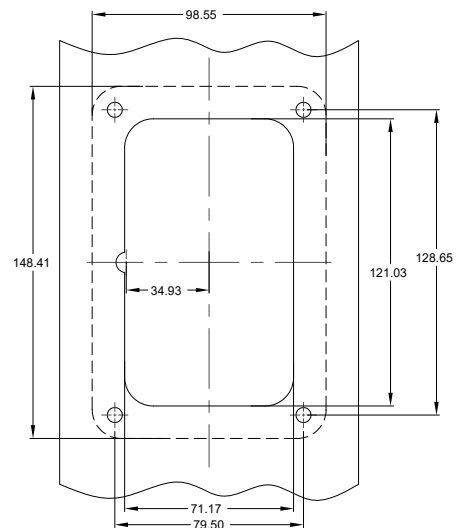

ARB Series™ - 102 Position - Interface Flange Panel Cutouts (in mm)

Note: See individual datasheets for specific dimensions relating to keying options





48 Position - ARB Series™ Plugs and Wedgelocks

(See individual datasheets on www.amphenol-sine.com for full specs, faceviews, keying location and product dimensions.)

Image	Part Number	Description	Size	Amp
	ARB16-48SAR-L018	48 Position, Plug, Socket, ARB Series™, Jackscrew, Reduced Diameter Seal (Green), Keyed A, Black Body (Requires Wedgelock AWB-48SA)	12, 16, 20	25A, 13A, 7.5A
	ARB16-48SBR-L018	48 Position, Plug, Socket, ARB Series™, Jackscrew, Reduced Diameter Seal (Green), Keyed B, Black Body (Requires Wedgelock AWB-48SB)	12, 16, 20	25A, 13A, 7.5A
	ARB16-48SCR-L018	48 Position, Plug, Socket, ARB Series™, Jackscrew, Reduced Diameter Seal (Green), Keyed C, Black Body (Requires Wedgelock AWB-48SC)	12, 16, 20	25A, 13A, 7.5A
	ARB16-48SDR-L018	48 Position, Plug, Socket, ARB Series™, Jackscrew, Reduced Diameter Seal (Green), Keyed D, Black Body (Requires Wedgelock AWB-48SD)	12, 16, 20	25A, 13A, 7.5A
	AWB-48SA	48 Position, Plug Wedgelock, Keyed A, Gray Body	-	-
	AWB-48SB	48 Position, Plug Wedgelock, Keyed B, Black Body	-	-
	AWB-48SC	48 Position, Plug Wedgelock, Keyed C, Green Body	-	-
	AWB-48SD	48 Position, Plug Wedgelock, Keyed D, Brown Body	-	-







48 Position - ARB Series™ Receptacles and Wedgelocks

(See individual datasheets on www.amphenol-sine.com for full specs, faceviews, keying location and product dimensions.)

	ARB12-48PAR-L018	48 Position, Receptacle, Pin, ARB Series™, Threaded Insert for Jackscrew, Reduced Diameter Seal (Green), Keyed A, Black Body (Requires Wedgelock AWB-48PA)	12, 16, 20	25A, 13A, 7.5A
	ARB12-48PBR-L018	48 Position, Receptacle, Pin, ARB Series™, Threaded Insert for Jackscrew, Reduced Diameter Seal (Green), Keyed B, Black Body (Requires Wedgelock AWB-48PB)	12, 16, 20	25A, 13A, 7.5A





48 Position - ARB Series™ Receptacles and Wedgelocks, cont.

(See individual datasheets on www.amphenol-sine.com for full specs, faceviews, keying location and product dimensions.)

Image	Part Number	Description	Size	Amp
	ARB12-48PCR-L018	48 Position, Receptacle, Pin, ARB Series™, Threaded Insert for Jackscrew, Reduced Diameter Seal (Green), Keyed C, Black Body (Requires Wedgelock AWB-48PC)	12, 16, 20	25A, 13A, 7.5A
	ARB12-48PDR-L018	48 Position, Receptacle, Pin, ARB Series™, Threaded Insert for Jackscrew, Reduced Diameter Seal (Green), Keyed D, Black Body (Requires Wedgelock AWB-48PD)	12, 16, 20	25A, 13A, 7.5A
	AWB-48PA	48 Position, Receptacle Wedgelock, Keyed A, Gray Body	-	-
	AWB-48PB	48 Position, Receptacle Wedgelock, Keyed B, Black Body	-	-
	AWB-48PC	48 Position, Receptacle Wedgelock, Keyed C, Green Body	-	-
	AWB-48PD	48 Position, Receptacle Wedgelock, Keyed D, Brown Body	-	-

48 Position - ARB Series™ Interface Flanges

(See individual datasheets on www.amphenol-sine.com for full specs, faceviews, keying location and product dimensions.)

	ARBF-2A	48 Position, Interface Flange, Receptacle Retaining Clip, Self-Threading, Flange Seal (Red), Keyed A, Black Body Note: A complete ARB Series™ mated assembly requires the use of an Interface Flange.	-	-
	ARBF-2B	48 Position, Interface Flange, Receptacle Retaining Clip, Self-Threading, Flange Seal (Red), Keyed B, Black Body Note: A complete ARB Series™ mated assembly requires the use of an Interface Flange.	-	-
	ARBF-2C	48 Position, Interface Flange, Receptacle Retaining Clip, Self-Threading, Flange Seal (Red), Keyed C, Black Body Note: A complete ARB Series™ mated assembly requires the use of an Interface Flange.	-	-
	ARBF-2D	48 Position, Interface Flange, Receptacle Retaining Clip, Self-Threading, Flange Seal (Red), Keyed D, Black Body Note: A complete ARB Series™ mated assembly requires the use of an Interface Flange.	-	-

102 Position - ARB Series™ Plugs and Wedgelocks

(See individual datasheets on www.amphenol-sine.com for full specs, faceviews, keying location and product dimensions.)

Image	Part Number	Description	Size	Amp
	ARB16-102SAR-L018	102 Position, Plug, Socket, ARB Series™, Jackscrew, Reduced Diameter Seal (Green), Keyed A, Black Body (Requires Wedgelocks AWB-51SAL and AWB-51SAR)	4, 8, 12, 16	100A, 60A, 25A, 13A
	ARB16-102SBR-L018	102 Position, Plug, Socket, ARB Series™, Jackscrew, Reduced Diameter Seal (Green), Keyed B, Black Body (Requires Wedgelocks AWB-51SBL and AWB-51SBR)	4, 8, 12, 16	100A, 60A, 25A, 13A
	ARB16-102SCR-L018	102 Position, Plug, Socket, ARB Series™, Jackscrew, Reduced Diameter Seal (Green), Keyed C, Black Body (Requires Wedgelocks AWB-51SCL and AWB-51SCR)	4, 8, 12, 16	100A, 60A, 25A, 13A
	ARB16-102SDR-L018	102 Position, Plug, Socket, ARB Series™, Jackscrew, Reduced Diameter Seal (Green), Keyed D, Black Body (Requires Wedgelocks AWB-51SDL and AWB-51SDR)	4, 8, 12, 16	100A, 60A, 25A, 13A
	AWB-51SAL	102 Position, Left Wedgelock for Plug (51 Position), Keyed A, Gray Body	-	-
	AWB-51SAR	102 Position, Right Wedgelock for Plug (51 Position), Keyed A, Gray Body	-	-
	AWB-51SBL	102 Position, Left Wedgelock for Plug (51 Position), Keyed B, Black Body	-	-
	AWB-51SBR	102 Position, Right Wedgelock for Plug (51 Position), Keyed B, Black Body	-	-
	AWB-51SCL	102 Position, Left Wedgelock for Plug (51 Position), Keyed C, Green Body	-	-
	AWB-51SCR	102 Position, Right Wedgelock for Plug (51 Position), Keyed C, Green Body	-	-
	AWB-51SDL	102 Position, Left Wedgelock for Plug (51 Position), Keyed D, Brown Body	-	-



102 Position - ARB Series™ Receptacles and Wedgelocks

(See individual datasheets on www.amphenol-sine.com for full specs, faceviews, keying location and product dimensions.)

Image	Part Number	Description	Size	Amp
	AWB-51SDR	102 Position, Right Wedgelock for Plug (51 Position), Keyed D, Brown Body	-	-
	ARB12-102PAR-L018	102 Position, Receptacle, Pin, ARB Series™, Threaded Insert for Jackscrew, Reduced Diameter Seal (Green), Keyed A, Black Body (Requires Wedgelocks AWB-51PAL and AWB-51PAR)	4, 8, 12, 16	100A, 60A, 25A, 13A
	ARB12-102PBR-L018	102 Position, Receptacle, Pin, ARB Series™, Threaded Insert for Jackscrew, Reduced Diameter Seal (Green), Keyed B, Black Body (Requires Wedgelocks AWB-51PBL and AWB-51PBR)	4, 8, 12, 16	100A, 60A, 25A, 13A
	ARB12-102PCR-L018	102 Position, Receptacle, Pin, ARB Series™, Threaded Insert for Jackscrew, Reduced Diameter Seal (Green), Keyed C, Black Body (Requires Wedgelocks AWB-51PCL and AWB-51PCR)	4, 8, 12, 16	100A, 60A, 25A, 13A
	ARB12-102PDR-L018	102 Position, Receptacle, Pin, ARB Series™, Threaded Insert for Jackscrew, Reduced Diameter Seal (Green), Keyed D, Black Body (Requires Wedgelocks AWB-51PDL and AWB-51PDR)	4, 8, 12, 16	100A, 60A, 25A, 13A
	AWB-51PAL	102 Position, Left Wedgelock for Receptacle (51 Position), Keyed A, Gray Body	-	-
	AWB-51PAR	102 Position, Right Wedgelock for Receptacle (51 Position), Keyed A, Gray Body	-	-
	AWB-51PBL	102 Position, Left Wedgelock for Receptacle (51 Position), Keyed B, Black Body	-	-
	AWB-51PBR	102 Position, Right Wedgelock for Receptacle (51 Position), Keyed B, Black Body	-	-
	AWB-51PCL	102 Position, Left Wedgelock for Receptacle (51 Position), Keyed C, Green Body	-	-
	AWB-51PCR	102 Position, Right Wedgelock for Receptacle (51 Position), Keyed C, Green Body	-	-



102 Position - ARB Series™ Receptacles and Wedgelocks, cont.

(See individual datasheets on www.amphenol-sine.com for full specs, faceviews, keying location and product dimensions.)

Image	Part Number	Description	Size	Amp
	AWB-51PDL	102 Position, Left Wedgelock for Receptacle (51 Position), Keyed D, Brown Body	-	-
	AWB-51PDR	102 Position, Right Wedgelock for Receptacle (51 Position), Keyed D, Brown Body	-	-

102 Position - ARB Series™ Interface Flanges

(See individual datasheets on www.amphenol-sine.com for full specs, faceviews, keying location and product dimensions.)

	ARBF-1A	102 Position, Interface Flange, Receptacle Retaining Clip, Self-Threading, Flange Seal (Red), Keyed A, Black Body Note: A complete ARB Series™ mated assembly requires the use of an Interface Flange.	-	-
	ARBF-1B	102 Position, Interface Flange, Receptacle Retaining Clip, Self-Threading, Flange Seal (Red), Keyed B, Black Body Note: A complete ARB Series™ mated assembly requires the use of an Interface Flange.	-	-
	ARBF-1C	102 Position, Interface Flange, Receptacle Retaining Clip, Self-Threading, Flange Seal (Red), Keyed C, Black Body Note: A complete ARB Series™ mated assembly requires the use of an Interface Flange.	-	-
	ARBF-1D	102 Position, Interface Flange, Receptacle Retaining Clip, Self-Threading, Flange Seal (Red), Keyed D, Black Body Note: A complete ARB Series™ mated assembly requires the use of an Interface Flange.	-	-

ARB Series™ - Contacts

For Contact options, refer to individual part number datasheets found online at www.amphenol-sine.com.

ARB Series™ - Tooling

For Tooling options, refer to individual part number datasheets found online at www.amphenol-sine.com.